

THIS DOCUMENT CONTAINS INFORMATION PROPRIETARY TO CADENCE DESIGN SYSTEMS INC (CADENCE). USE OR DISCLOSURE WITHOUT THE WRITTEN PERMISSION OF AN OFFICER OF CADENCE IS EXPRESSLY FORBIDDEN. COPYRIGHT (C) CADENCE

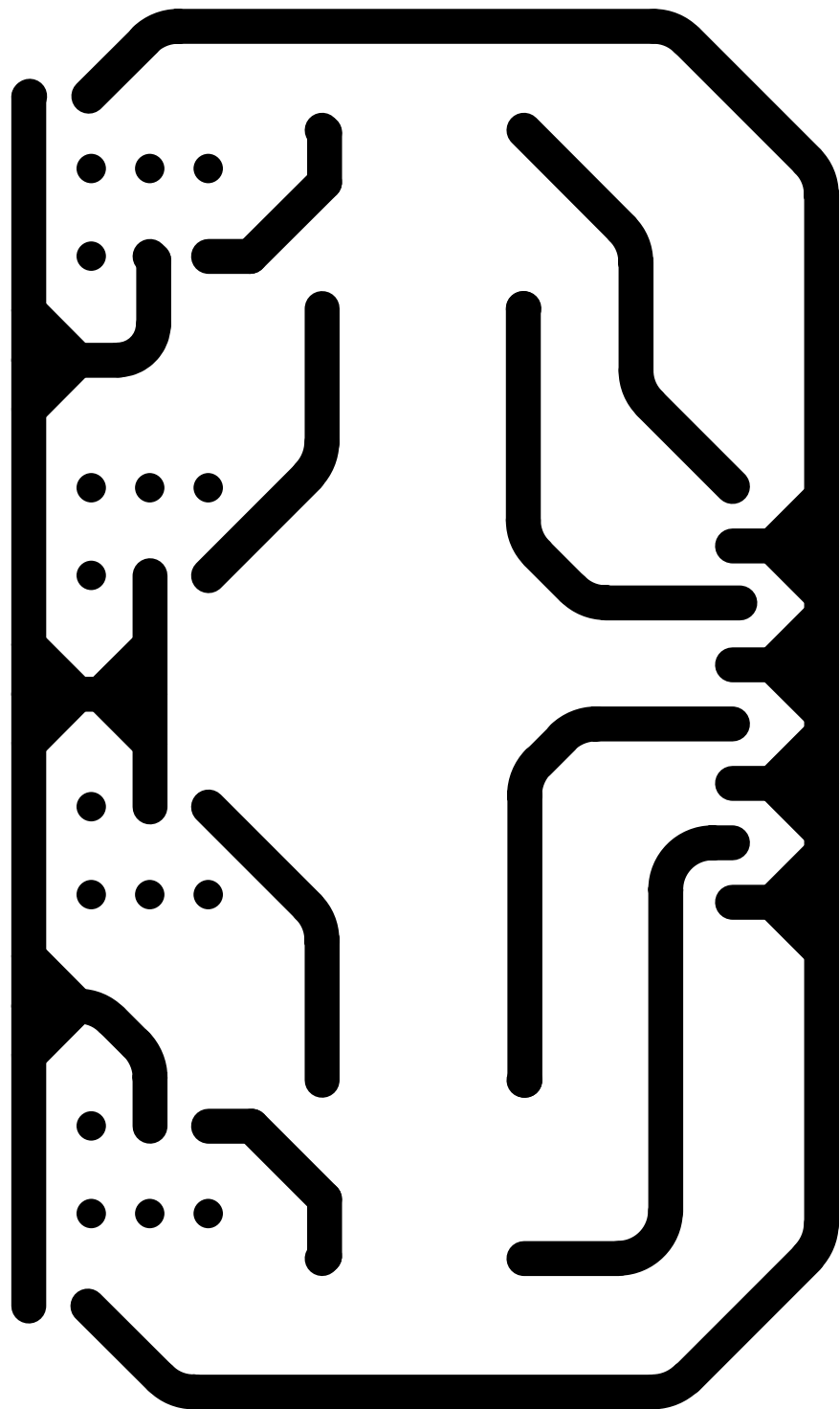

TITLE:	DATE:
ENGINEER:	PAGE:

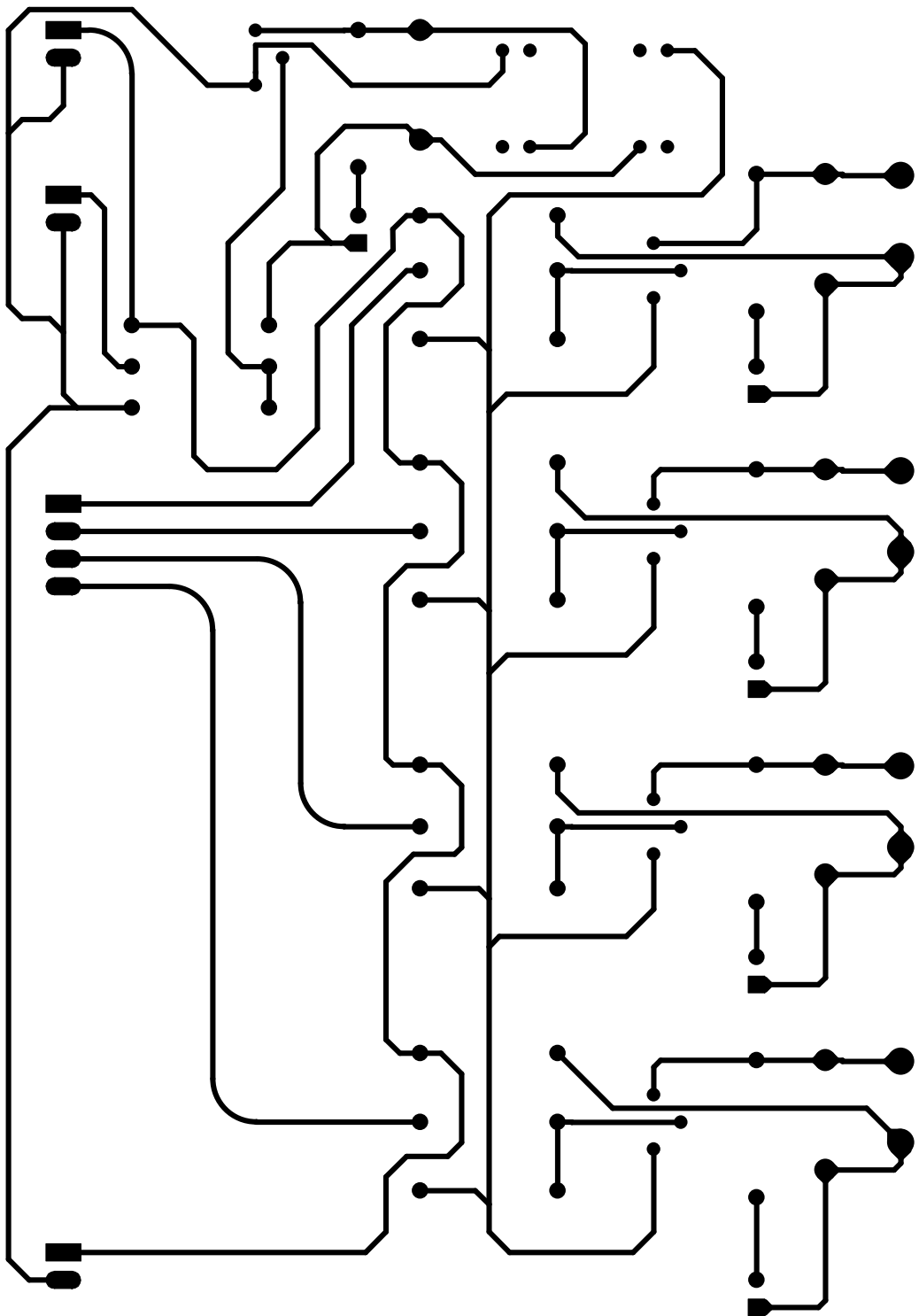

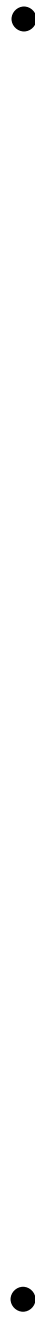

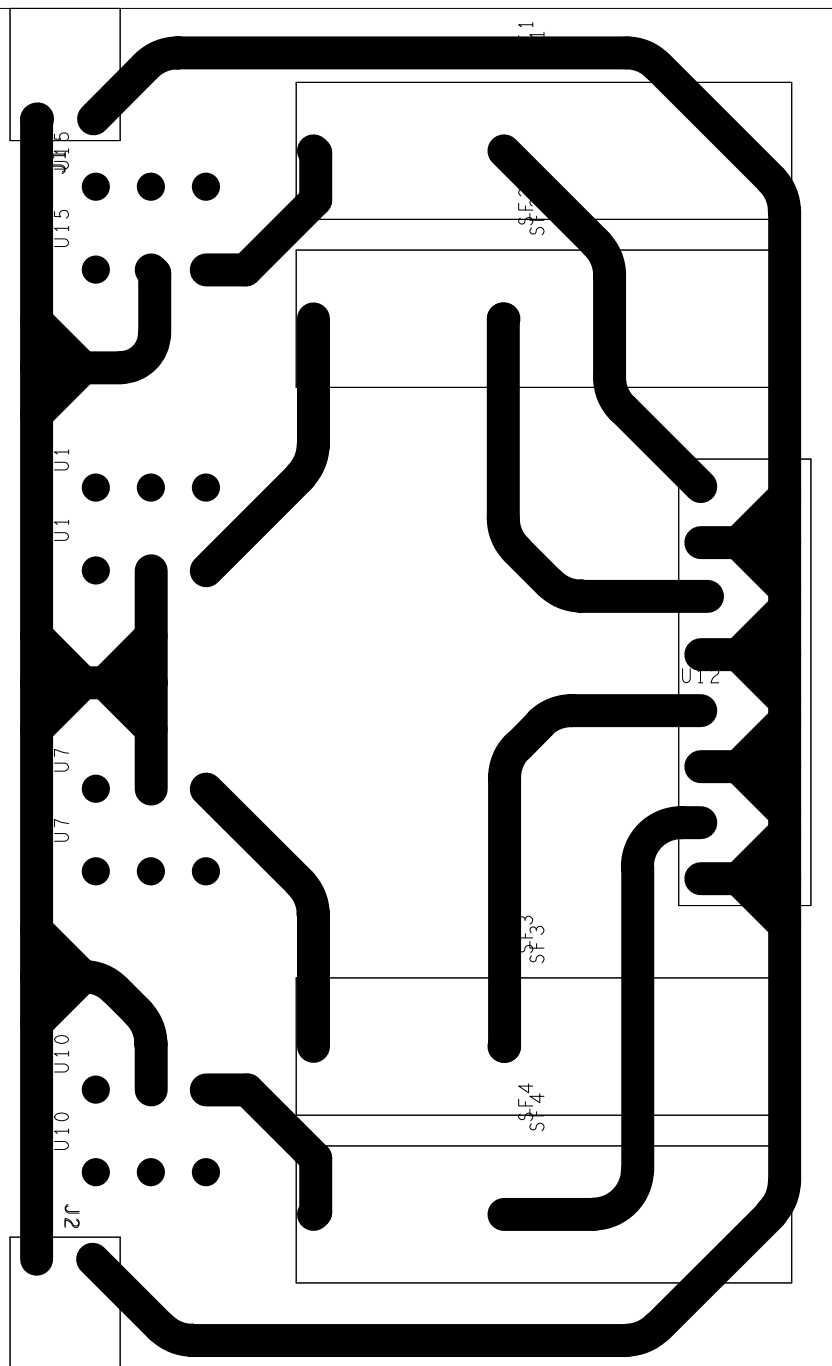
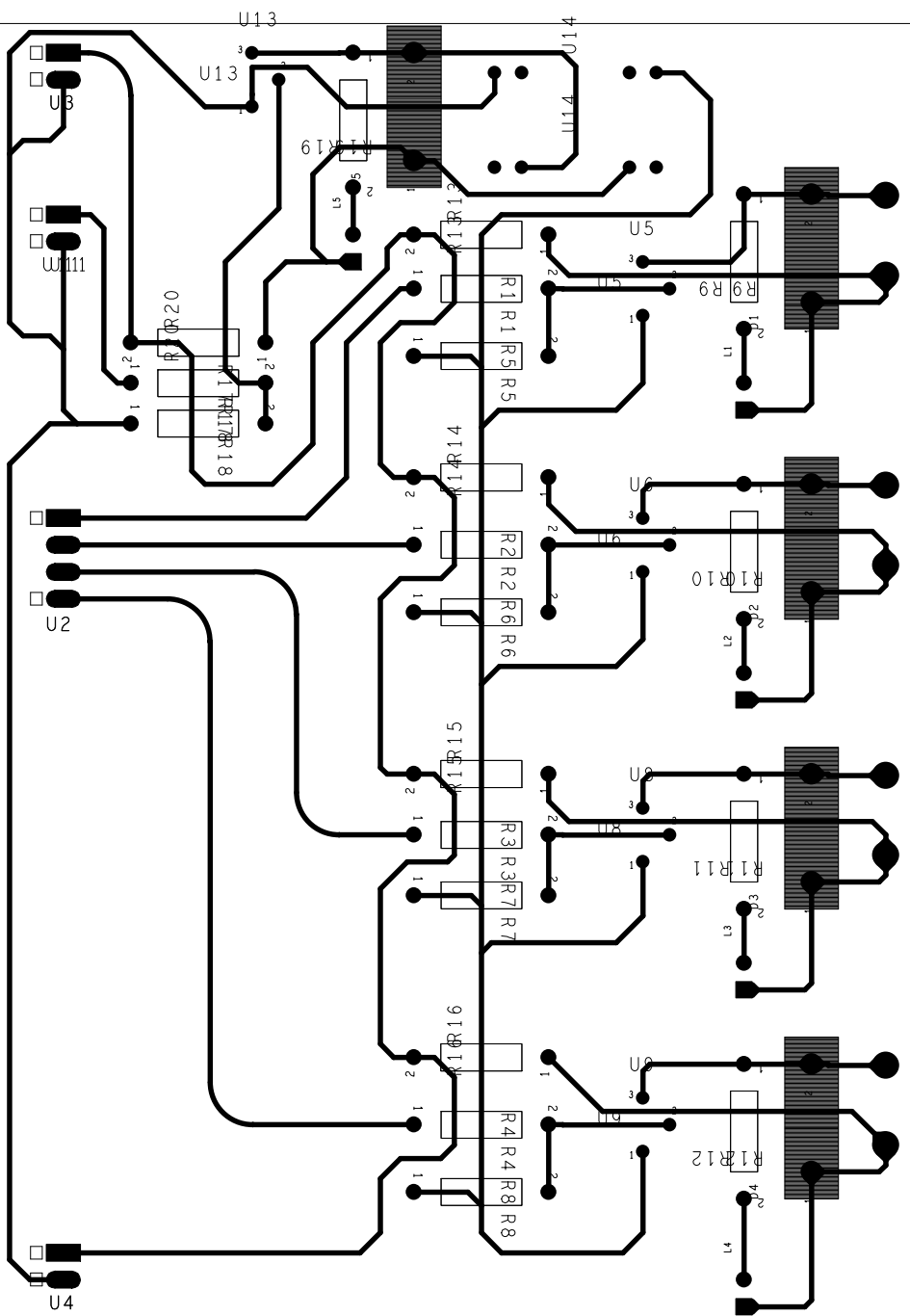

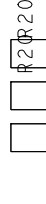
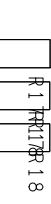
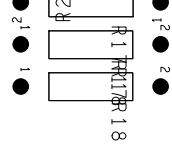
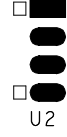

U13

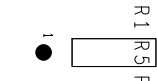
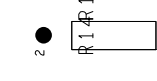
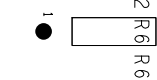
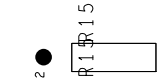
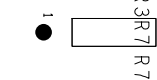
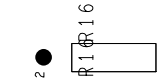
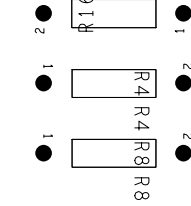

U14 U14

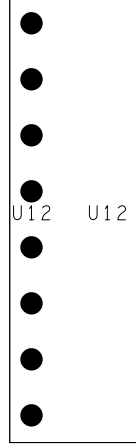
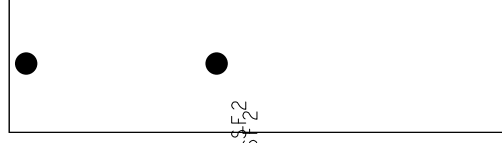
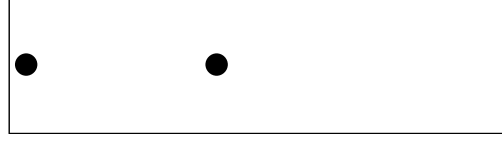
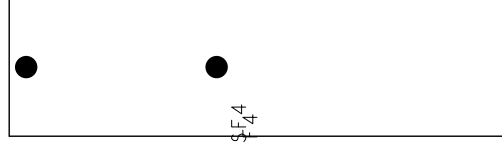
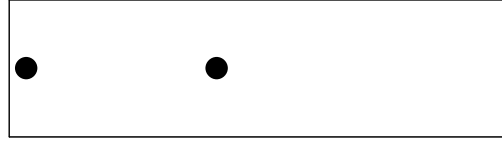
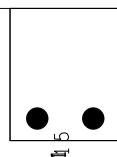
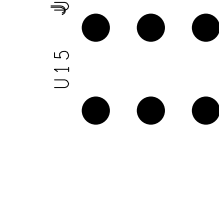
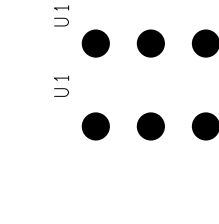
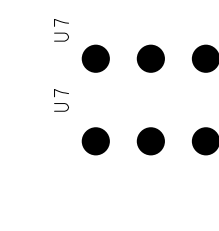
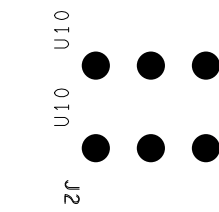
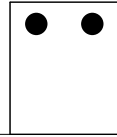
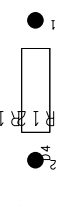
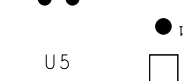
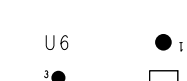
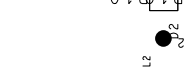
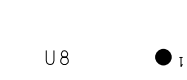
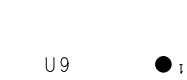
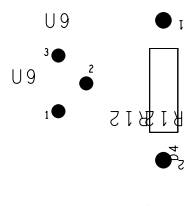

SF4

SF3

SF2

SF1

U12 U12

